

Fabrication and Performance of a Donut-Shaped Generator Based on Dielectric Elastomer

Ran Hee Lee,¹ Utpal Basuli,¹ Min-Young Lyu,² Eun Soo Kim,³ Changwoon Nah¹

¹BK-21 Plus Haptic Polymer Composite Research Team, Department of Polymer-Nano Science and Technology, Chonbuk National University, Jeonju 561-756, Republic of Korea

²Department of Mechanical System Design Engineering, Seoul National University of Science and Technology, Seoul 139-743, Republic of Korea

³Department of Electrical and Electronics Engineering, Jeonju University, Jeonju 560-759, Republic of Korea

Correspondence to: C. Nah (E-mail: cnah@jbnu.ac.kr)

ABSTRACT: Dielectric elastomers (DEs) have been suggested as generators to harvest electrical energy from natural mechanical energy sources, such as human movements and ocean waves. In this study, a donut-shaped DE generator (DEG) has been fabricated and its performance is characterized depending on the stretch deformation. A simple new stretchable electrode system using multi-walled carbon nanotubes has been suggested. Measurements on the resistance, capacitance, and electrical power generation are made depending on the area expansion. The capacitance and harvested energy are parabolically increased with increased area expansions. The theoretical prediction of energy harvesting is in good agreement with measured values of capacitance changes with stretching. FE analysis is also applied for calculation of strains for the DEG to figure out the distribution of strains. It is suggested that the DEG has promising applications in the field of designing an energy harvesting device depending on the type of energy available. © 2013 Wiley Periodicals, Inc. *J. Appl. Polym. Sci.* **2014**, *131*, 40076.

KEYWORDS: elastomers; rubber; sensors and actuators; stimuli-sensitive polymers

Received 7 August 2013; accepted 13 October 2013

DOI: 10.1002/app.40076

INTRODUCTION

Recently, there has been a greater interest in the issue of green and renewable electrical energies. Various attempts and relevant researches have been made for harvesting electrical powers with higher efficiency based on various materials, notably piezoelectric materials¹ and electroactive polymers (EAPs).² Dielectric elastomers (DEs), notably acrylic and silicone rubbers, is one class of EAP to be used as actuators and generators which can directly transform between the mechanical and electrical energy.^{2–8} Comparing with other EAP materials such as electrostrictive polymers, conducting polymers, and polymer gels, DEs have many advantages of low cost, high deformation, no toxicity, high resistance to corrosion, quick response, high energy densities, and high conversion efficiency, which make them potentially well suited for development of power generators from natural energy sources such as ocean wave, heel-strike, winds, and waterfalls.^{5,9–13} Thus the harvested energy is clean, unlimited, pollution-free, and environmentally friendly.^{10,14,15}

The DE generator (DEG) uses a very simple structure of sandwiched elastomer sheet with compliant electrodes (Figure 1). This structure resembles conventional capacitors, where the

capacitance is dependent on the area (A) and thickness between two electrodes (t), as is given below^{10,15}:

$$C = \frac{\epsilon\epsilon_0 A}{t} \quad (1)$$

where ϵ and ϵ_0 are the relative dielectric constant and permittivity of free space (8.85×10^{-12} F/m), respectively. Since the unfilled elastomer vulcanizates show the Poisson's ratio of ~ 0.5 , the volume is nearly constant during the stretch deformation.⁶ If the sheet is expanded to be double (thickness reduces to be one half), the capacitance increases to four times higher. Thus the DE capacitor can be considered as a variable capacitor, since the capacitance is easily and efficiently controlled by changing the degree of stretch. When the stretched DEG is charged [high capacitance, Figure 1(a)] and it is allowed to contract due to elastic nature of elastomer [low capacitance, Figure 1(b)], the elastic stresses in the film works against the electric field pressure, thus increasing electrical energy. In this process, like charges are compressed together, while opposite charges are pushed farther apart. Electrically, this change raises the voltage of the charge.^{3,5} Pelrine and coworkers proposed the harvesting energy calculation for the system as follows¹⁰:

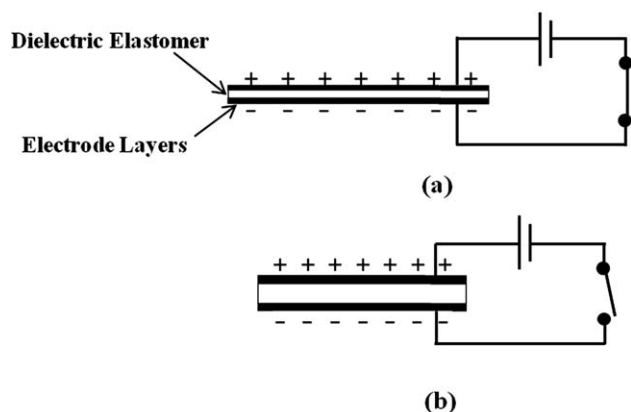

Figure 1. Schematic representation of dielectric elastomer generator (a) at stretched state with low voltage and (b) at relaxed state with high voltage.

$$E = 0.5 C_1 V_b^2 \left(\frac{C_1}{C_2} - 1 \right) \quad (2)$$

where C_1 and C_2 are the capacitance at stretched and relaxed state, respectively and V_b is the bias voltage when the film is stretched. The amount of energy from DEG is thus determined by the maximum deformation without dielectric breakdown. It is also related not only to the operation frequency, but also its geometry.¹⁰ Various geometries including donut-shape have been proposed by many research groups.^{16,17} However, relatively little information is available in the literature.

A donut-shaped DEG was designed and fabricated using an acrylic rubber (AR) vulcanizate and stretchable electrode. The

performance of the DEG was evaluated based on the electrical resistance, capacitance, and harvested energy, and they were compared with the suggested theory for energy harvesting.¹⁰ The strain and its distribution were analyzed using a finite element method (FEM) analysis.

EXPERIMENTAL

Materials

Commercial grade (VHBTM 4910, 3M, USA) dielectric AR with higher energy density (~ 0.4 J/g) compared with single crystal piezo ceramics (0.13 J/g)¹⁵ was chosen as a base material to produce a dielectric generator. VHBTM 4910 is known as a pressure sensitive adhesive elastomeric film with chemically cross-linked amorphous polyacrylate network.^{18,19} A paste type of conductive carbon greases (MG Chemicals, Canada) was selected as the base part of the stretchable electrodes. A multi-walled carbon nanotube (MWNT, CM250 grade, purity 95%, average diameter 10–15 nm, average length 0.5–40 μm , Hanwha Nanotech, Korea) was used as an additional layer of the stretchable electrodes for the sake of providing better conductivity and stability during stretching.

Design and Fabrication of Disk-Shaped Generator

Various shapes of DEGs have been proposed so far for applications in either small-scale energy harvesting^{20–22} or large-scale energy harvesting.¹⁰ A donut-shaped DEG was designed based on the work by Anderson and coworkers.^{16,17} Figure 2 shows the schematic diagram and actual photos of the DEG at initial and stretched states. The procedure of the fabrication of the DEG is as follows. A disk-shape (diameter: 88 mm) of AR sheet

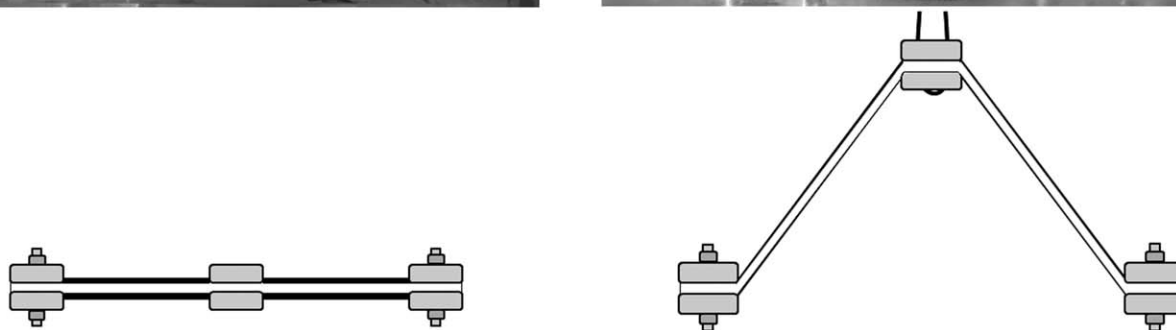
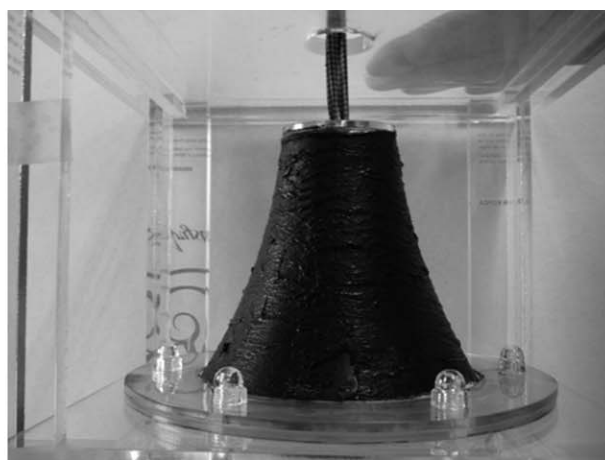

Figure 2. Photographs and side view of donut-shaped DEG at initial (left) and stretched (right) conditions.

of 1 mm in thickness was radially expanded by 100% in area and the expanded AR sheet was fixed between the two acrylic plastic rings (inner and outer diameter of 120 and 180 mm, respectively, and thickness of 3 mm), and they were tightened with six evenly spaced bolt and nut systems to prevent any slipping at the clamping regions. The center region of the AR sheet was sandwiched by two small acrylic plastic disks (diameter: 50 mm), and this part was designed to move freely upward. Before applying the stretchable electrodes, a conducting copper tape (0.07 mm in thickness, Samwon, Korea) connected to a leading copper wire of 1 mm was bonded to inner and outer surfaces of AR sheet under the stretching of 248% in area expansion. The area expansion of the DEG system was determined by a simple geometrical relation between height of inner part and surface area of truncated cone under the assumption of perfect truncated shape of DEG under stretching by lifting vertically upward. The inner part was manually lifted vertically by 0, 40, 60, 80, 100, and 120 mm. The corresponding surface area expansions, defined by the ratio of expanded area to initial one in percentage, were calculated to be 0, 66.7, 123.6, 184.8, 248, and 312.3%. For maximizing the stability of electrodes during operation of DEG, the conducting tape was adhered on the region close to outer clamping rings, because that region would realize the lowest stretching. Then flexible and stretchable electrode made of carbon grease was coated both the inner and outer surfaces. A mixture of MWNT with carbon grease was additionally coated to the electrode layer for the sake of further reducing the electrical resistance.

Characterization of Performance

The electrical resistance of outer and inner surfaces was initially measured using a multimeter (Keithley Model 2000, USA) at 248% area expansion, and it was continuously measured for reduced expansions of 184.8, 123.6, 66.7, and 0% to understand the efficiency and stability of the stretchable electrode system in this study. The averaged values of resistance at inner and outer surfaces were reported in the later section.

The capacitance of the disk-shaped DEG model was measured using a LCR meter (NumetriQ Model PSM1735, UK) at a frequency of 1 kHz to evaluate the performance of the generator by changing the stretch level. The degree of stretch was controlled by area expansions of 0, 66.7, 123.6, 184.8, 248, and 312.3%. The change in capacitance upon stretch is very important in determining the performance of the generator, since the harvested energy is closely related with it, as is proposed in eq. (2).

The electrical energy of the disk-shaped DEG was also measured using an oscilloscope (TDS 3044B, Tektronix, USA) depending on the area expansions of 0, 66.7, 123.6, 184.8, 248, and 312.3%. A typical electrical circuit based on the work by Pelrine et al.¹⁵ was adopted in this study. As shown schematically in Figure 3, the circuit consists of input bias voltage (V_b), resistance (R), diode, a variable capacitor (disk-shaped DEG), and a load. All the variables were optimized after numerous trials and errors to obtain the proper output signals. A resistance of 10 M Ω was the best choice for the case of bias voltage of

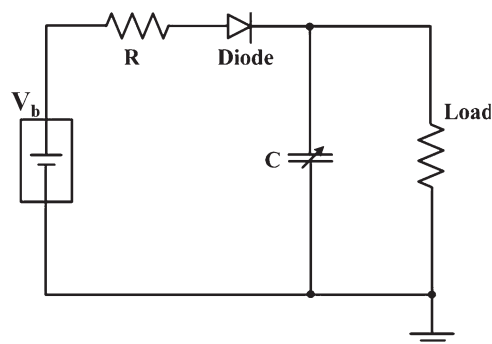

Figure 3. Schematic diagram of the circuit used to harvest the electrical energy.

24.8 V in this study. A diode was used to prevent the back flow of current during relaxation process (generating mode).

FE Analysis of Strain

The FEM has been widely used for analyzing strains or stresses of complicated geometries and structures.²³ Energy harvesting in the donut-shaped DEG is influenced by the degree of stretch in the rubber films coated with electrodes. The area expansions in this study were determined by simple calculation of area under the assumption of truncated cone geometry when the center part was stretched vertically upward. However, the real geometry of the DEG would not give the exact shape of truncated cone. It rather shows somewhat inward curved lines (Figure 2) under stretching, indicating non-uniform strains on the surfaces. To figure out more accurate strains and strain distribution, a FE analysis was employed for the DEG.

Figure 4 shows the mesh for the finite element analysis. This model has external diameter 110 mm, internal diameter 50 mm, and thickness of about 0.53 mm. Density, Young's modulus, and Poisson's ratio of rubber film used in this finite element analysis were 960 kg/m³, 1.8 MPa, and 0.49, respectively. The external diameter was set to be a fixed condition, while the internal diameter was set to be a displacement condition. The mesh type for the three dimensional finite element analysis was hexahedral and the number of finite element was 21,328. Using the ANSYS Workbench, static structural analysis of the model was established. The height of upward displacement of inner part was varied by 0, 40, 60, 80, 100, and 120 mm.

RESULTS AND DISCUSSION

Electrical Resistance

The stretchable electrode is one of the important issues in the development of dielectric elastomer-based actuators and generators because of huge extensional deformations up to ~300%.² Paste-types based on carbons and silvers have been widely accepted for such an application of large deformation. But one of drawbacks of such electrodes is that the resistance goes up extremely after a certain level of extension. In an attempt to overwhelm the problem, an additional electrode layer composed of the mixture of MWNT and carbon grease was employed over the conventional carbon grease layer. Figure 5 shows the variation in the resistance as a function of area expansion. The resistance of inner and outer electrodes under 248% area

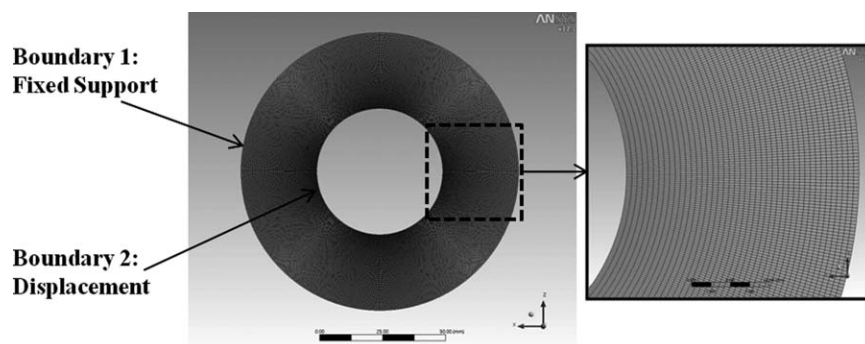

Figure 4. Mesh and boundary conditions used in the finite element analysis.

expansions was around 1 k Ω . Since the electrode was coated under this expansion, the observed resistance seems to be inherent values for the two-layer electrodes in this study, which is much lower level compared to that of single layer of carbon grease (10–10² k Ω). This might be due to the higher number of conducting path by fibrous carbon nanotubes formed in the second layer of carbon nanotubes. The resistance reduces linearly with decreasing area expansion (contraction due to elasticity of AR), and it reaches to 0.2 k Ω at initial state. This can be explained by the fact that when the AR sheet is contracted the inner and outer surface areas will be reduced, leading to more compacted conducting layers (thicker layers). This will increase in the conducting path among conducting particles of carbons and carbon nanotubes. Thus, the proposed stretchable conducting layer system is a reasonable candidate for such applications.

Capacitance

The change in capacitance of DEG depending on the stretching level plays a crucial role in production of electrical power, as predicted in eq. (2). The capacitance of the disk-shaped DEG was measured at different area expansions of 0, 66.7, 123.6, 184.8, 248, and 312.3%. The result is shown in Figure 6 as a function of area expansion. The capacitance increases somewhat parabolically with area expansion. This is interesting to note since eq. (1) predicts a linear relation between conductivity (C) versus area (A). This can be explained by considering typical incompressible

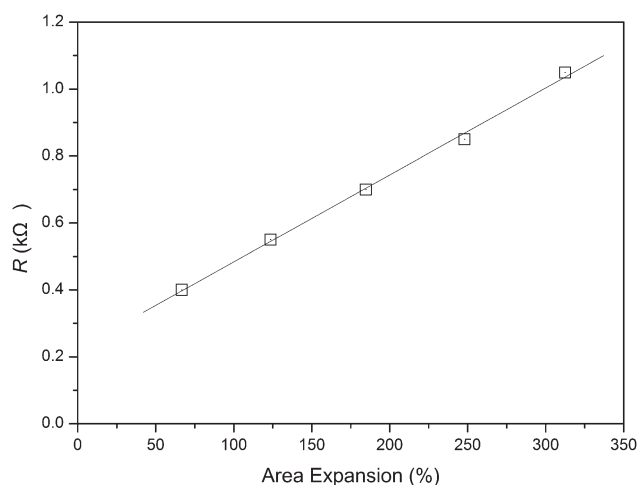

Figure 5. Electrical resistance (R) of donut-shaped DEG as a function of area expansion.

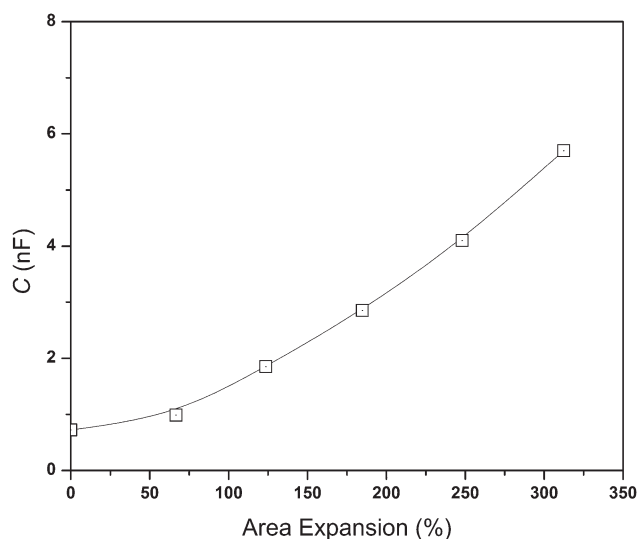

Figure 6. Capacitance (C) of donut-shaped DEG as a function of area expansion.

nature of crosslinked DEs like AR sheet in this study. This means that almost no volume change occurs before and after deformation.²⁴ Thus, the area expansion results in a reduction in

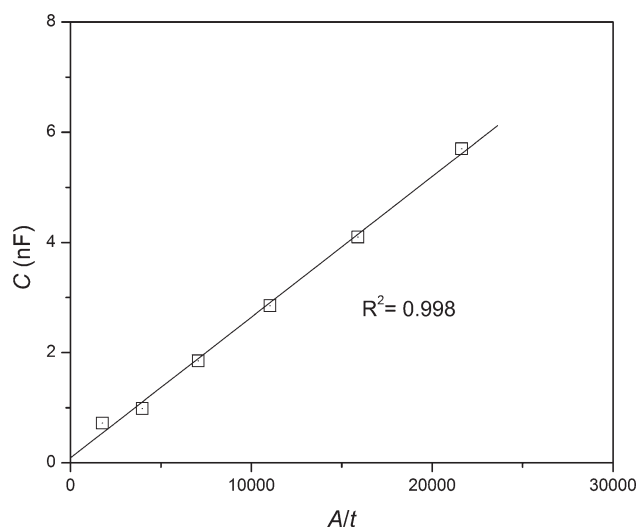

Figure 7. Capacitance (C) of donut-shaped DEG as a function of the ratio of area to thickness (A/t).

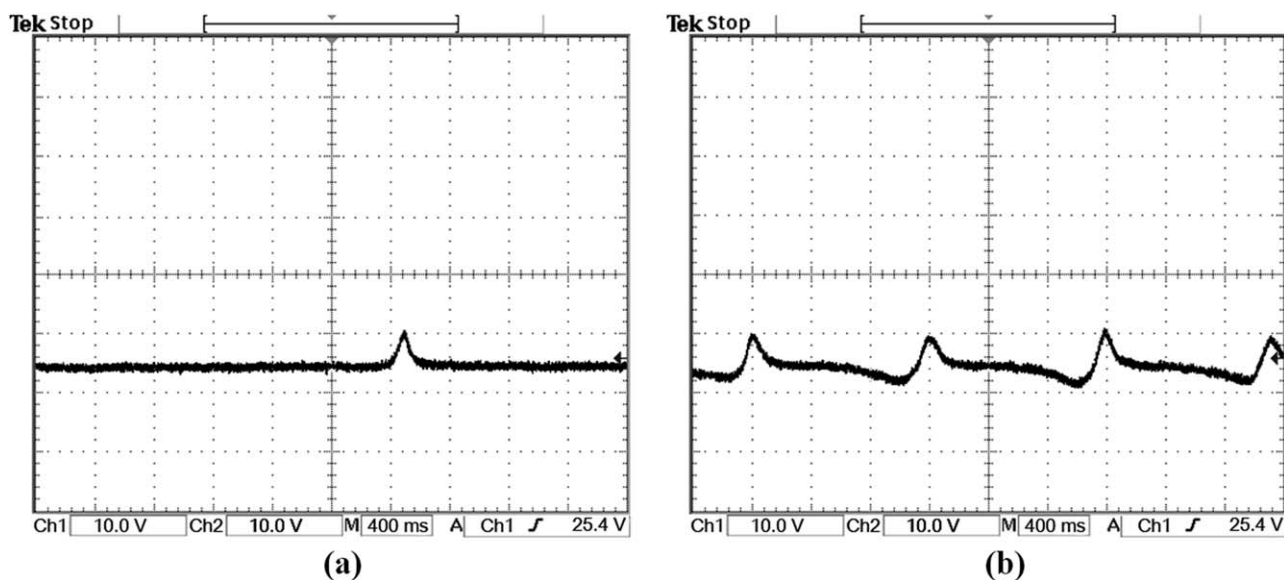

Figure 8. A typical output voltage signal from an oscilloscope for (a) single cycle deformation and (b) continuous cyclic deformation at 312.3% surface expansion.

thickness leading an additional increase in the capacity. To verify this, the capacitance (C) is plotted again with the ratio of area to thickness (A/t) in Figure 7. A linear relation with a correlation coefficient of $R^2 = 0.998$ is seen between the C and A/t . This again supports that the DEG can be considered as a variable capacitor which follows the basic rule given by eq. (1).

Harvested Energy

Figure 8 shows typical electrical harvested voltage peaks above the bias voltage (V_b) from the oscilloscope output signals for a single cyclic deformation (a) and continuous cyclic deformation (b) of 312.3% of area expansion. The height of the output peak was 4.8 V (approximately 20% of the bias voltage of 24.8 V) and the time span was 320 ms, which is comparable with the observation by Pelrine et al.¹⁵ Figure 9 represents a plot of the measured output voltage along with calculated harvested energy by eq. (2) based on the measured values of C_2 (initial state) and

C_1 at various stretched states, and bias voltage of $V_b = 24.8$ V as a function of area expansion. The electrical voltage and corresponding energy is parabolically increasing with increased area expansion. The parabolic increase can be again explained by the incompressible nature of rubber materials as described earlier.

Now to confirm the validity of theoretical prediction of energy harvesting based on DEG, eq. (2) was slightly modified under an assumption of constant initial capacitance (C_2) as follows:

$$\frac{E}{C_1} = \alpha C_1 - \beta \quad (3)$$

where two constants are defined by $\alpha = 0.5V_b^2/C_2$, $\beta = 0.5V_b^2$, respectively. Figure 10 shows a plot of E/C_1 versus C_1 . A clear linear relationship was observed suggesting a fairly good agreement between experimental measurement and the theoretical prediction.

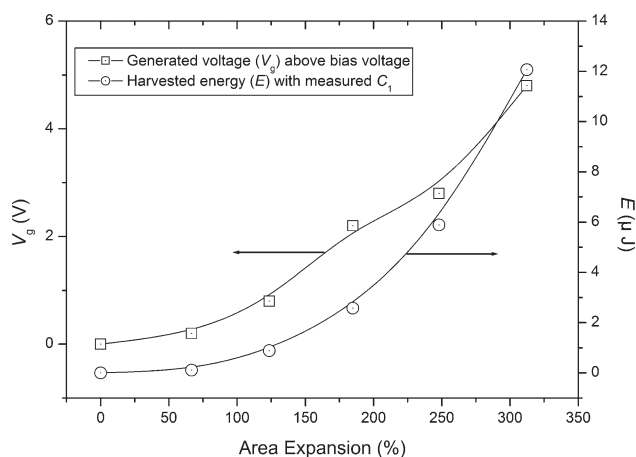

Figure 9. Measured generated output voltage (V_g) above the bias voltage (24.8 V) and calculated harvested energy (E) based on experimentally determined C_1 values as a function of area expansion.

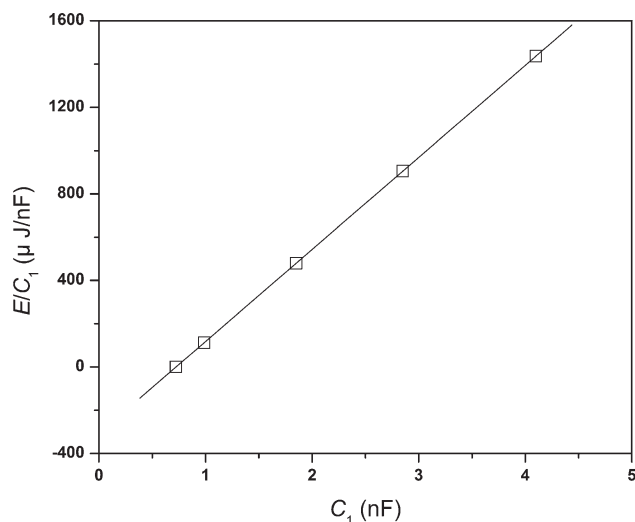

Figure 10. Plot of ratio of energy to capacitance at stretched state (E/C_1) as a function of capacitance (C_1).

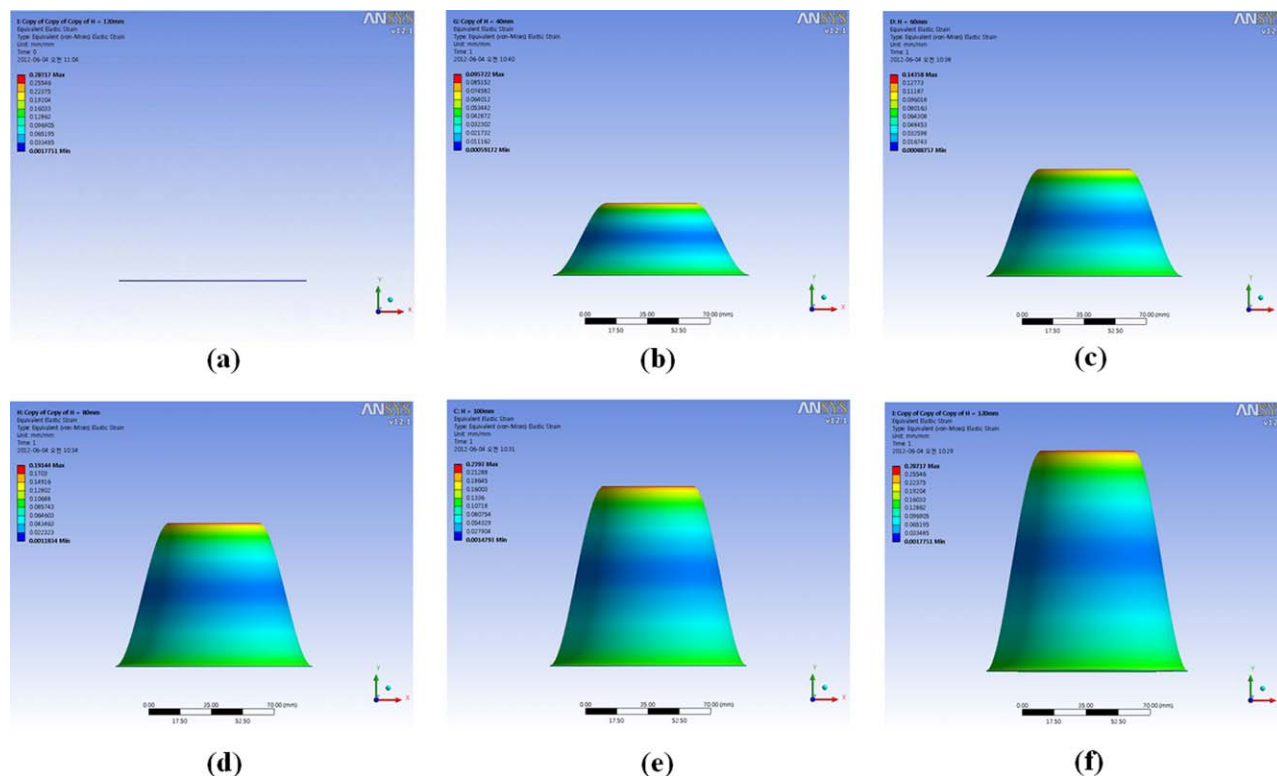

Figure 11. Distribution of strain of the DEG at area expansions of (a) 0, (b) 66.7, (c) 123.6, (d) 184.8, (e) 248, and (f) 312.3%. Red color side represents the higher strain level. [Color figure can be viewed in the online issue, which is available at wileyonlinelibrary.com.]

By considering the highest stretching case (312.3% area expansion), approximately $12 \mu\text{J}$ of energy can be harvested during one cycle deformation. If we assume the deformation frequency of 3 Hz and 24.8 V bias voltage, about 3.1 J of electrical energy can be accumulated for one day. The higher electrical energy can also be harvested by increasing the size of DEG, bias voltage, frequency, and deformation. Thus, the donut-shaped DEG system can be a

candidate for such applications as generators based on various mechanical resources including waves, water fall, and winds.

FE Analysis of Strain

In order to figure out the surface strain and its distribution of the DEG, a FE analysis was carried out. Figure 11 shows the distribution of equivalent strains under different stretching conditions.

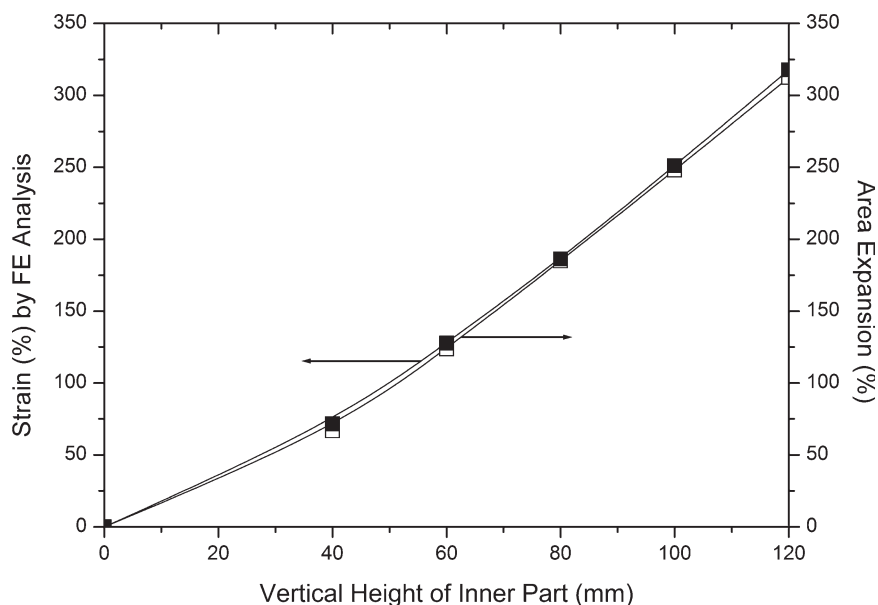

Figure 12. Comparison of surface strains by FE analysis with area expansion.

The calculated strains were not uniform at a given area expansion. The surface strains were the highest at the vicinity of inner and outer disks. Somewhat less strains were found in the middle regions. Clearly the strain distributions along the radial direction on the rubber surface were nonlinear. Thus, it can be expected that the harvested energy will also give non-uniform distribution all over the surface of the DEG. The higher strain regions will produce higher energies.

To verify the validity of using area expansions by simple geometrical calculation, the regional strains were averaged and they are represented as the surface strain in percent by dividing them with the initial surface area with no stretching. The results are given in Figure 12 as a function of vertical height of inner part. A fairly good agreement was found between them. A slightly higher (~7%) values were observed for surface strain by FE analysis since actual shape of stretched DEG was a slightly concave truncated cone showing additional strains. Thus the assumption of exact truncated cone was found to be a reasonable approximation in the calculation of surface area expansion under stretching.

CONCLUSIONS

A donut-shaped generator based on dielectric elastomer (AR) was successfully fabricated with a new stretchable/flexible electrode system composed of MWNTs. The electrical resistance of the new electrode system was much lower than those of conventional carbon grease.

As the generator was stretched, the capacitance increased parabolically and accordingly both the harvested electrical voltage and electrical energy increased in similar fashion. About 3.1 J of electrical energy can be harvested per day under the assumptions of 312.3% area expansion, 3 Hz of cyclic deformation, and 24.8 V bias voltage. The harvesting energy prediction was found to give reasonable values when the precisely measured values of capacitance under different stretching conditions.

The FE analysis predicted precise surface expansion profiles of rubber film for the height displacement of inner part. Regions at the vicinity of outer and inner parts showed larger strains, whereas central regions of rubber film showed the lower strains. These uneven strain distributions in the surface made expanded surface profile nonlinear. A fairly good agreement was found between surface strain by FE analysis and area expansion by assumption of truncated cone structure of DEG system under stretching.

The generator system of simple structure can be a strong candidate for applications as generators acting by various mechanical resources such as sea waves, waterfalls, and winds.

ACKNOWLEDGMENTS

This research was supported by both the World Class University (WCU) Program of the Korea Science and Engineering Foundation, funded by the Ministry of Education, Science and Technology (R33-2008-000-10016-0) and a research grant (10040003) from the Ministry of Knowledge Economy of Korea. The authors would like to dedicate this work to Professor Alan N. Gent, who passed away last year (2012).

REFERENCES

1. Anton, S. R.; Sodano, H. A. *Smart Mater. Struct.* **2009**, *16*, R1.
2. Bar-Cohen, Y. *Electroactive Polymer (EAP) Actuators as Artificial Muscles: Reality, Potential, and Challenges*, 2nd ed.; SPIE Press: Washington, **2004**.
3. Pelrine, R.; Kornbluh, R.; Pei, Q.; Joseph, J. *Science* **2000**, *287*, 836.
4. Pelrine, R.; Kornbluh, R.; Kofod, G. *Adv. Mater.* **2000**, *12*, 1223.
5. Prahlad, H.; Kornbluh, R.; Pelrine, R.; Stanford, S.; Eckerle, J.; Oh, S. *Proceedings of International Conference on Smart Materials, Structures and Systems*, Bangalore, India, **2005**.
6. Trujillo, R.; Mou, J.; Phelan, P. E.; Chau, D. S. *Int. J. Adv. Manuf. Technol.* **2004**, *23*, 176.
7. Ma, W.; Cross, L. E. *Appl. Phys. A* **2004**, *78*, 1201.
8. Wang, H.; Zhang, Q. M.; Cross, L. E.; Ting, R.; Coughlin, C.; Rittenmyer, K. *Proc. Int. Symp. (IEEE, State College)* **1994**, *9*, 182.
9. Lin, G.; Wang, K.; Chen, M.; Wang, Y. *Proceedings of 20th International Offshore and Polar Engineering Conference*, Beijing, China, **2010**.
10. Chiba, S.; Waki, M.; Kornbluh, R.; Pelrine, R. *Proc. SPIE* **2008**, *6927*, 692715.
11. Chiba, S.; Waki, M.; Kornbluh, R.; Pelrine, R. *Proc. SPIE* **2007**, *6524*, 652424.
12. Chiba, S.; Pelrine, R.; Kornbluh, R.; Prahlad, H.; Stanford, S.; Eckerle, J. *J. Jpn. Inst. Energy* **2007**, *86*, 743.
13. Kornbluh, R.; Pelrine, R.; Pei, Q.; Heydt, R.; Stanford, S.; Oh, S. *Proc. SPIE* **2002**, *4698*, 254.
14. Kang, G. S.; Kwon, J. H.; Choi, J. D.; Kim, J. H.; Cho, K. H.; Kim, K. S.; Kim, S. H. *Korean Soc. Precision Eng.* **2010**, 809.
15. Pelrine, R.; Kornbluh, R.; Eckerle, J.; Jeuck, P.; Oh, S.; Pei, Q.; Stanford, S. *Proc. SPIE* **2001**, 4329.
16. McKay, T.; O'Brien, B.; Calius, E.; Anderson, I. *Proc. SPIE* **2010**, *7642*, 764216.
17. McKay, T.; O'Brien, B.; Calius, E.; Anderson, I. *Smart Mater. Struct.* **2010**, *19*, 055025.
18. Data page of 3M™ VHB™ series tapes, http://www.3m.com/us/mfg_industrial/bonding/pdf/501622.pdf; MSDS: No.4905 and 4910 "VHB" acrylic foam tape and No. 967, 968, 9460, 9469 and 9473 "VHB" adhesive transfer tapes, March 09, 1998 (both available from www.3m.com).
19. <http://multimedia.3m.com/mws/mediawebservlet?66666UuZj cFSLXTtnxMtLXs6EVu- QEcuZgVs6EVs6E666666>.
20. Pelrine, R.; Kornbluh, R.; Eckerle, J.; Jeuck, P.; Oh, S.; Pei, Q.; Stanford, S. *Proc. SPIE* **2001**, *4329*, 148.
21. Jean-Mistral, C.; Basrou, S.; Chaillout, J. J. *Proc. SPIE* **2008**, *6927*, 692716.
22. Iskandarani, Y. H.; Jones, R. W.; Villumsen, E. *Proc. SPIE* **2009**, *7287*, 72871Y.
23. Kolondzovski, Z.; Petkovska, L. *Serbian J. Electron. Eng.* **2005**, *2*, 157.
24. Timoshenko, S. P.; Goodier, J. N. *Theory of Elasticity*, 3rd ed.; McGraw-Hill Publishing Company: New York, **1934**; p 8.